



HOW TO MAKE A HOME RUN.™

Use And Care

G U I D E



A Note to You	2
Dishwasher Safety	3
Parts and Features	4
Starting Your Dishwasher	6
Loading Your Dishwasher	7
Using the Dispensers	12
Setting the Controls	14
Selecting a wash cycle	14
Canceling a cycle	15
Selecting cycle options	16
Changing a cycle setting ...	16
Changing an option setting	16
Adding an item during a cycle	17
Using delay wash	17
The clean signal light	17
Washing Special Items	18
Caring for Your Dishwasher	19
Saving Energy	21
Solving Common Dishwashing Problems	22
Troubleshooting	25
Requesting Assistance or Service	26
Index	30
Warranty	32

1-800-253-1301

Call our Consumer Assistance Center with questions or comments.

DISHWASHER MODEL SERIES 900, 915

12/95

PART NO. 3376813 Rev. A

A Note to You

Thank you for buying a WHIRLPOOL® appliance.

Because your life is getting busier and more complicated, WHIRLPOOL dishwashers are easy to use, save time, and help you manage your home better. To ensure you enjoy years of trouble-free operation, we developed this Use and Care Guide. It contains valuable information about how to operate and maintain your appliance properly and safely. Please read it carefully.

Also, please complete and mail the Ownership Registration Card provided with your appliance. This card helps us notify you about any new information on your appliance.

Please record your model's information.

Whenever you call to request service for your appliance, you need to know your complete model number and serial number. You can find this information on the model and serial number label (see diagram on page 4 for location of label).

Please also record the purchase date of your appliance and your dealer's name, address, and telephone number.

Model Number _____

Serial Number _____

Purchase Date _____

Dealer Name _____

Dealer Address _____

Dealer Phone _____

Keep this book and the sales slip together in a safe place for future reference.

**Our Consumer Assistance Center
number is toll-free 24 hours a day.**

1-800-253-1301

Help us help you

Please:

- Have your dishwasher installed by a qualified installer.
- Install where dishwasher is protected from the elements.
- Install and level dishwasher on a floor that will hold the weight, and in an area suitable for its size and use.
- Properly connect dishwasher to electricity, water, and drain.*
- Remove all shipping plugs from hoses and connectors (such as the cap on the drain outlet) before installing.*
- Remove all hang tags and temporary labels.
- Make sure dishwasher is not used by anyone unable to operate it properly.
- Properly maintain dishwasher. See page 19.

* See Installation Instructions for complete information.

Dishwasher Safety

Your safety is important to us.

This guide contains safety statements under warning symbols. Please pay special attention to these symbols and follow any instructions given. Here is a brief explanation of the use of the warning symbol.

WARNING

This symbol alerts you to such dangers as fire, electrical shock, burns, and injury.

IMPORTANT SAFETY INSTRUCTIONS

WARNING

To reduce the risk of fire, electrical shock, or injury when using your dishwasher, follow basic precautions including the following:

- Read all instructions before using the dishwasher.
- Use the dishwasher only for its intended function.
- **DISHWASHER MUST BE ELECTRICALLY GROUNDED.** Read the Installation Instructions for details.
- Use only detergents or rinse agents recommended for use in a dishwasher, and keep them out of the reach of children.
- When loading items to be washed:
 - Locate sharp items so that they are not likely to damage the door seal.
 - Load sharp knives with the handles up to reduce the risk of cut-type injuries.
- Do not wash plastic items unless they are marked "dishwasher safe" or the equivalent. For plastic items not so marked, check the manufacturer's recommendations.
- Do not touch the heating element during or immediately after use. Do not reach into the area below the bottom rack until the heating element has cooled for at least 20 minutes.
- Do not operate your dishwasher unless all enclosure panels are properly in place.
- Do not tamper with controls.
- Do not abuse, sit on, or stand on the door or dish racks of the dishwasher.
- To reduce the risk of injury, do not allow children to play in or on a dishwasher.
- Under certain conditions, hydrogen gas may be produced in a hot water system that has not been used for two weeks or more. **HYDROGEN GAS IS EXPLOSIVE.** If the hot water system has not been used for such a period, before using the dishwasher turn on all hot water faucets and let the water flow from each for several minutes. This will release any accumulated hydrogen gas. As the gas is flammable, do not smoke or use an open flame during this time.
- Remove the door to the washing compartment when removing an old dishwasher from service or discarding it.
- Do not store or use gasoline or other flammable vapors and liquids in the vicinity of this or any other appliance. The fumes can create a fire hazard or explosion.
- Disconnect electrical power to the dishwasher before attempting to service.

– SAVE THESE INSTRUCTIONS –

Parts and Features

Your dishwasher is illustrated below with the parts and features called out. To help you find information on specific parts or features quickly, page references are included.

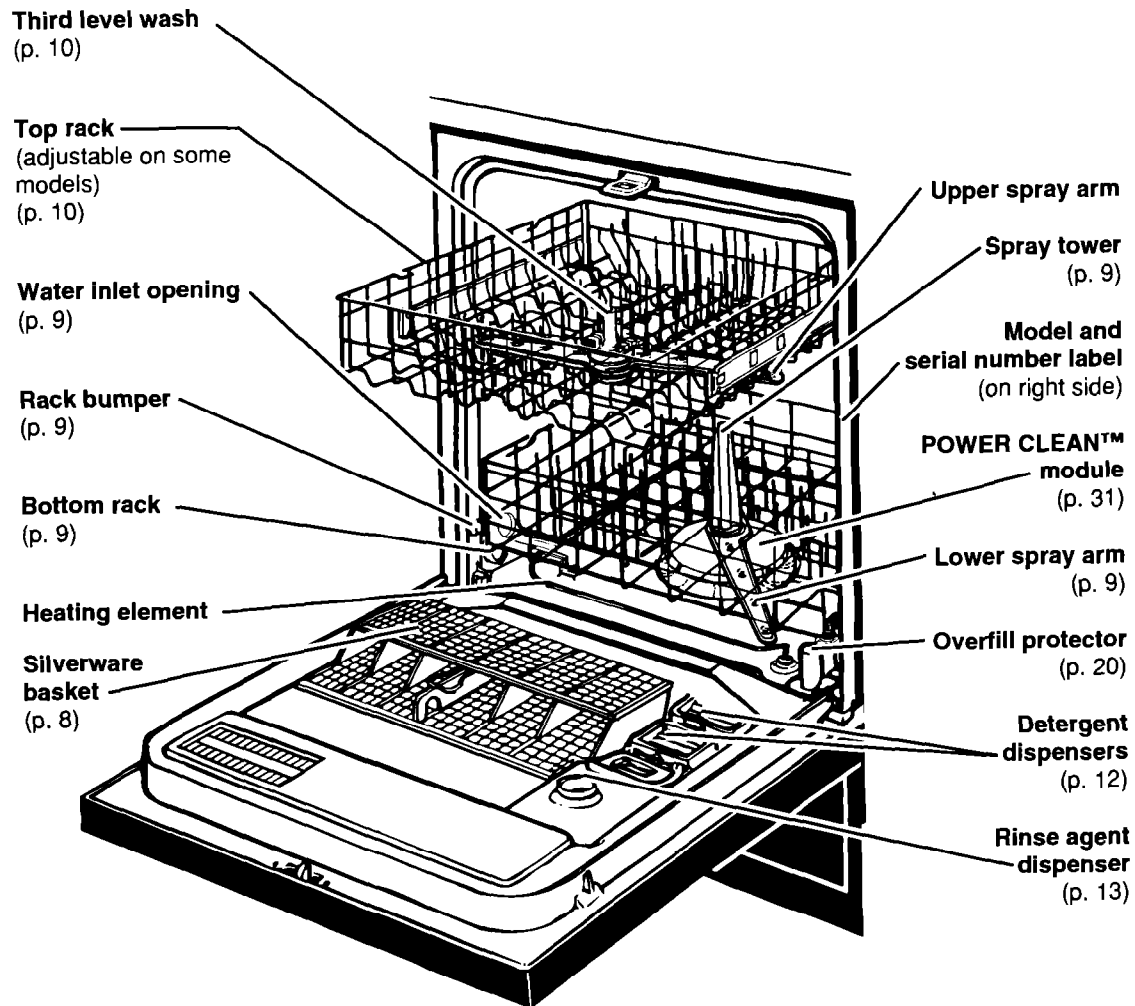

PARTS AND FEATURES

Control panels

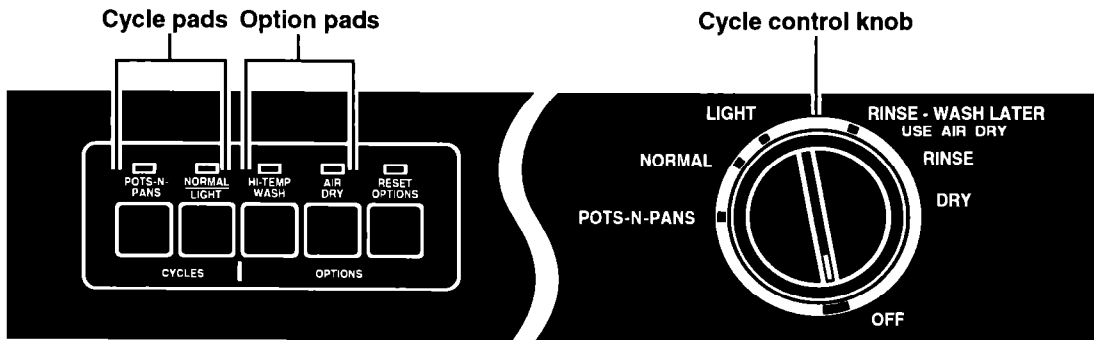

900 Model Series

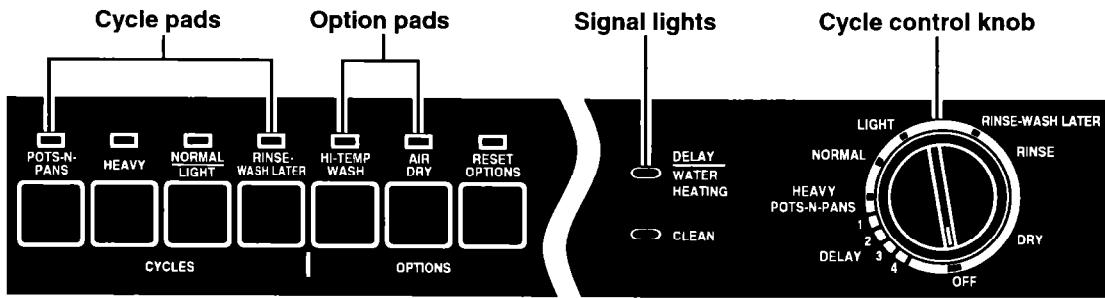

915 Model Series

Starting Your Dishwasher

This section tells you how to start or stop your dishwasher. Refer to it for quick reference.

Starting a wash cycle

1. Load the dishwasher. See pages 7-11.



2. Spin the spray arms. They should turn freely.

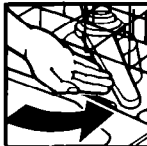

3. Add detergent. See page 12.



4. Add rinse agent, if needed. See page 13.



5. Close door firmly until it latches.

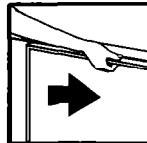

6. Run hot water at the sink nearest the dishwasher until water is hot. Turn water off. (See page 21.)



7. Press a Cycle pad. If desired, press one or more Option pads. (See pages 14-16.) The indicator above each pad will show red when selected.

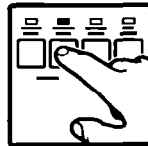

NOTE: More than one cycle shares the same pad. The cycle control knob determines which cycle operates.

8. Turn the cycle control knob clockwise to the desired cycle. You will feel a definite "stop" at each cycle mark. The dishwasher automatically starts the cycle you select.

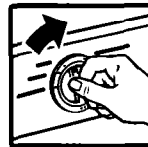

NOTE: If the door is latched, you will hear the cycles start and stop as the control knob passes each cycle mark. This is normal and does not hurt the dishwasher. If you prefer, you can set the cycle control knob with the door unlatched.

Stopping the dishwasher

You can stop your dishwasher anytime during a cycle. All you have to do is:

- Open the door slightly. Wait for any filling or spraying action to stop before opening the door all the way. Close the door to continue the cycle.

OR

- Turn the cycle control knob slowly clockwise until you hear water draining. Let the dishwasher drain completely. Then open the door and turn the cycle control knob to Off.

Loading Your Dishwasher

This section tells how to properly load your dishwasher for best washing and rinsing results.

Preparing to load your dishwasher

- To save water and energy, do not rinse dishes before putting them into the dishwasher.
- Remove large pieces of food, bones, and other hard items. The POWER CLEAN™ module removes food particles from the water. The module contains a chopping device which reduces the size of food items.
NOTE: If hard items such as fruit seeds, nuts, and egg shells enter the POWER CLEAN module, you might hear chopping, grinding, crunching, or buzzing sounds. Those sounds are normal when hard items enter the module. **Do not** let metallic items (such as pot handle screws) get into the POWER CLEAN module. Damage can occur.
- Foods like eggs, rice, pasta, and cooked cereals may be hard to remove if left to dry over a period of time. Run a Rinse-Wash Later cycle to keep dishes moist if you do not plan to wash them soon.
- Load dishes so soiled surfaces face the rotating spray arm.
- Load dishes so they are not stacked or overlapping. It is important for the water spray to reach all soiled surfaces for best washing. For best drying, water must be able to drain from all surfaces.

Loading for quiet operation

- Secure lightweight load items in the racks.
- Pot lids and handles, pizza pans, cookie sheets, etc., should not touch interior walls, interfere with the spray arm's rotation, or cover the spray tower.
- Load dishes so they do not touch one another.

NOTE: Keep sink drain plugs inserted during dishwasher operation to prevent noise transfer through drains.

LOADING YOUR DISHWASHER

Loading the silverware basket

- Load the silverware basket while it is in the door or take the basket out for loading on a counter or table.
- Mix items in each section of the basket with some pointing up and some down to avoid nesting. Spray cannot reach nested items. However, always load sharp items (knives, skewers, forks, etc.) pointing down.
- Put small items (baby bottle caps, jar lids, etc.) in any section.
- You can also remove the basket for easy unloading. Always unload or remove the basket before unloading the racks to avoid spilling water on the silverware.

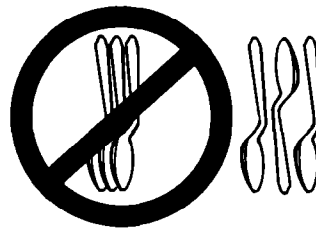
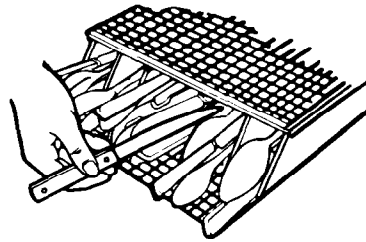

To remove the basket:

1. Grab the basket by the handle and slide it toward the top of the door.
2. Lift the basket off the holding buttons.

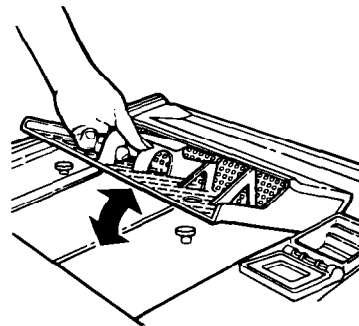

To replace the basket:

1. Set the basket on the holding buttons.
2. Slide the basket towards the bottom of the door until it locks in place.

To open the basket:

- Unhook the latch as shown.

NOTE: Be sure the cover is completely latched before pulling out the bottom rack and before closing the dishwasher door.

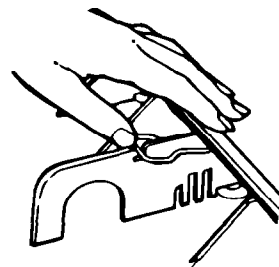

Loading the bottom rack

Load items with cooked-on or dried-on food in the bottom rack, with soiled surfaces facing inward to the spray.

Mixed load

- Load plates, soup bowls, etc., between prongs and facing inward to the spray.
- Make sure pot handles and other items do not stop rotation of the spray arms. Spray arms must move freely.
- Load items so they do not block or cover the spray tower.
- Load heavily soiled cookware face down in rack.
- Do not stack or overlap dishes. Water spray must reach all soiled surfaces for best results.

Mixed load

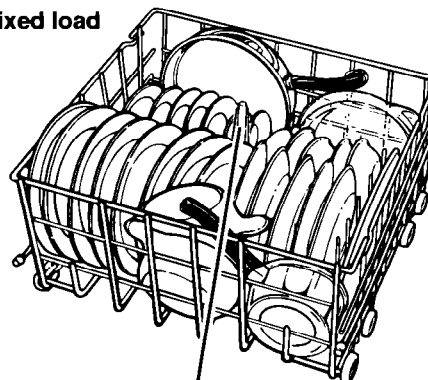

Do not cover spray tower

Utensil load

- Load cookie sheets, cake pans, and other large items at sides and back. Loading such items in front may keep water spray from reaching detergent dispenser and silverware basket.

Utensil load



Bumpers must face dishwasher door

NOTE:

- Do not load glasses, cups, or plastic items in the bottom rack.
- Do not load items between the bottom rack and the side of the dishwasher tub. This can block the water inlet opening.
- If you have removed the bottom rack for unloading or cleaning, replace it with bumpers in front.

LOADING YOUR DISHWASHER

Loading the top rack

Load the top rack with cups, glasses, and other small items. Do not cover the third level wash when loading the top rack.

Cup and glass load

- Load so open ends face down for cleaning and draining.
- Load glasses in top rack only – bottom rack is not designed for glasses. Damage can occur.
- Place items in the rows **between** prongs. Placing them over the prongs may lead to breakage.
- Secure lightweight items.
- China, crystal, and other delicate items must not touch each other during dishwasher operation. Damage may occur.

Cup and glass load

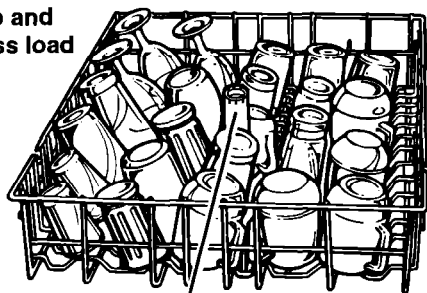

Do not cover third level wash

Mixed load

- Small bowls, pans, and other dishes can be placed in the top rack.
- Load plastic items in the top rack only. Plastic items may melt in the bottom rack.
- Wash only plastic items marked "dishwasher safe."
- Load plastic items so the force of the spray does not move them during the cycle.

Mixed load

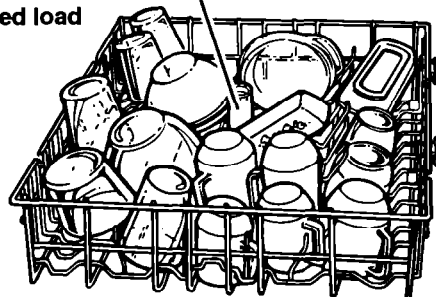

Infinite adjustable top rack (on some models)

Raise or lower the rack to fit tall items in either the top or bottom rack. The top rack does not have to be level.

- Turn the knob clockwise to raise a side of the rack.
- Turn the knob counterclockwise to lower a side of the rack.

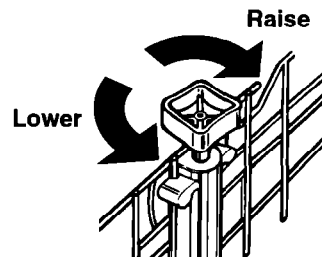

LOADING YOUR DISHWASHER

Adjustable 3-position top rack (on some models)

You can raise or lower the rack to fit tall items in either the top or bottom rack. The high and low positions are marked on the adjuster on the side facing the center of the dishwasher.

1. Hold top rack with one hand near adjuster.
2. Pull top of adjuster lever out with other hand.
3. Lift or lower rack to one of the preset positions.
4. Release adjuster lever.
5. Repeat Steps 1-4 for the 3 remaining adjusters as needed. The 4 adjusters can be raised or lowered separately or together, as desired. The top rack does not have to be leveled.

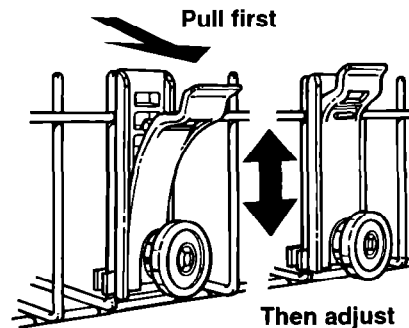

Using the Dispensers

For best washing results, review the information below. It is important to use detergents and rinse agents properly.

Using the detergent dispenser

- Use automatic dishwashing detergent **only**. Other detergents are too mild and much too sudsy.
- Add detergent just before starting cycle.
- Store tightly closed detergent in a cool, dry place. **Fresh automatic dishwasher detergent results in better cleaning.**

Filling the detergent dispenser

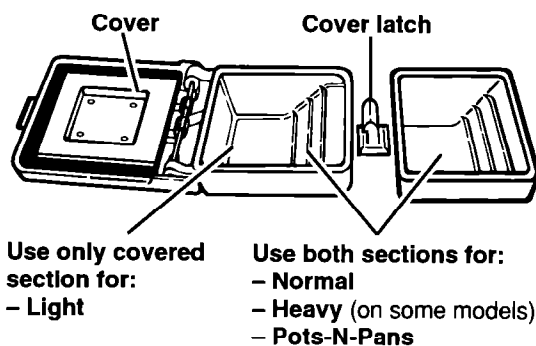

The detergent dispenser has one section with a cover and one without. Push the cover down firmly until it latches. Detergent in the open section falls into the dishwasher when closing the door. The covered section opens automatically for the main wash.

NOTE: It is normal for the cover to open partially when dispensing detergent.



How much detergent to use

- The amount of detergent to use depends on the hardness of your water and the type of detergent. If you use too little, dishes won't be clean. If you use too much in soft water, glassware will etch.
- Different brands of dishwasher detergent have different amounts of phosphorus for softening water. If you have hard water and use a detergent with a phosphorous content of less than 8.7%, you may need to use more detergent, or use a detergent with a phosphorous content higher than 8.7%.
- Find out your water's hardness by asking your local water department or water softener company.

WATER TYPE	WHERE TO FILL
Hard 8+ grains per gallon 136+ parts per million	Top of 3rd step (3 tbs) 
Medium 5-7 grains per gallon 85-119 parts per million	Top of 2nd step (2 tbs) 
Soft 0-4 grains per gallon 0-68 parts per million	Top of 1st step (1 tbs) 

Fill amounts shown are for standard powdered detergent. Amounts may vary if you use liquid or concentrated powdered detergent. Follow manufacturer's directions when using liquid dishwasher detergent or concentrated powdered detergent.

Using the rinse agent dispenser

Keep the rinse agent dispenser filled with a liquid rinse agent. **A rinse agent greatly improves dish drying by helping water flow off them during the last rinse.** A rinse agent also keeps water from forming droplets and drying as spots or streaks.

A small amount of rinse agent automatically releases into the rinse water during the final rinse of each cycle. **For best drying results, check dispenser periodically to see if it needs filling.**

To check dispenser:

- Check center of fill indicator cap. Clear means it needs filling.
- OR**
- Remove fill indicator cap. An "E" is visible when dispenser is empty.



OR

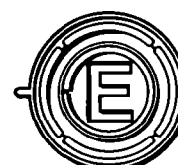

Cap center clear
when empty

"E" visible
when empty

To fill dispenser:

The rinse agent dispenser holds 6 ounces. Under normal conditions, this lasts about 3 months.

1. Open dishwasher door completely.
2. Remove fill indicator cap.
3. Add rinse agent. Fill to smallest opening in lower part of dispenser only. Overfilling may cause rinse agent to leak out. This will not harm the dishwasher, but could cause oversudsing.
4. Clean up any spilled rinse agent with a damp cloth.
5. Replace fill indicator cap. Keep it closed tightly.

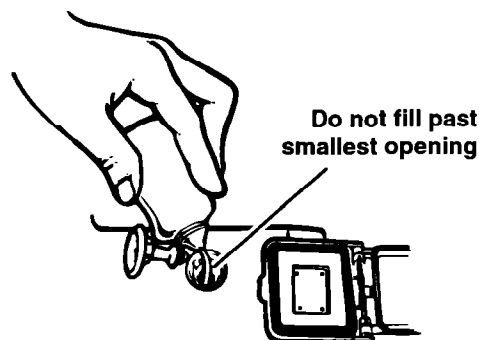

Keep dispenser filled for best drying results



NOTE: You do not have to wait until the dispenser is empty before refilling, but do not overfill it. Your dishwasher is designed to use a liquid rinse agent. Do not use a solid or bar-type rinse agent.

Setting the Controls

Operating your dishwasher's controls properly helps you obtain the best possible washing results. This section tells you how to select wash cycles and options.



Selecting a wash cycle

Press a Cycle pad. (Some cycles share the same pad.) Turn the cycle control knob to the desired cycle.

CYCLE	A "✓" shows what each cycle includes						CYCLE TIME (Minutes)
	WASH	RINSE	MAIN WASH	RINSE	FINAL RINSE	DRY	
POTS-N-PANS  Double wash for maximum cleaning of cooked-on or baked-on foods. <ul style="list-style-type: none"> • The water heats to 140°F in both washes (marked †). • The water heats to 140°F in the final rinse (marked ††). 	✓†	✓	✓†	✓	✓††	✓	76*
HEAVY (on some models)  Double wash for cleaning heavily soiled loads. <ul style="list-style-type: none"> • Select Hi-Temp Wash to heat water in the main wash (marked †). • The water heats to 140°F in the final rinse (marked ††). 	✓	✓	✓†	✓	✓††	✓	76*
NORMAL  Double wash for normal, everyday soiled loads. (The Energy Guide label is based on this cycle.) <ul style="list-style-type: none"> • Select Hi-Temp Wash to heat water in the main wash (marked †). • The water heats to 140°F in the final rinse (marked ††). 	✓		✓†	✓	✓††	✓	66*

* Cycle time includes dry time and may be longer depending on the temperature of water entering the dishwasher. The cooler the water, the longer the cycle time. If the water is already hot enough, the cycle times will be as shown. The cycle control knob does not move while water is being heated.

SETTING THE CONTROLS

CYCLE	A "✓" shows what each cycle includes						CYCLE TIME (Minutes)
	WASH	RINSE	MAIN WASH	RINSE	FINAL RINSE	DRY	
<p>LIGHT</p>  <p>Single wash for prerinsed or lightly soiled loads.</p> <ul style="list-style-type: none"> • Select Hi-Temp Wash to heat water in the main wash (marked †). • The water heats to 140°F in the final rinse (marked ††). 			✓†	✓	✓††	✓	60*
<p>RINSE-WASH LATER</p>  <p>For rinsing a few items to be washed 1 or more days later.</p> <ul style="list-style-type: none"> • Do not use detergent. <p>On 900 Model Series:</p> <ul style="list-style-type: none"> • The water heats to 140°F in the final rinse (marked †). • Select the Air Dry Option when using this cycle. <p>On 915 Model Series:</p> <ul style="list-style-type: none"> • Air Dry is automatically selected. 				✓	✓†		16**

* Cycle time includes dry time and may be longer depending on the temperature of water entering the dishwasher. The cooler the water, the longer the cycle time. If the water is already hot enough, the cycle times will be as shown. The cycle control knob does not move while water is being heated.

** Cycle time may be longer on 900 Model Series depending on the temperature of water entering the dishwasher.

Canceling a cycle

You can cancel a cycle at any time.

1. Turn the cycle control knob slowly clockwise until you hear water draining. Let the dishwasher drain completely.
2. Open the door.
3. Turn the cycle control knob to Off.

SETTING THE CONTROLS

Selecting cycle options

If desired, press one or more Option pad(s). You can press an Option pad after the dishwasher starts as long as the cycle has not passed the point that the option is used. For example, you can press Air Dry any time before the cycle control knob reaches Dry.

Hi-Temp Wash

When Hi-Temp Wash is selected, the dishwasher heats the water during the main wash of the Light, Normal, and Heavy cycles. Heating the water helps improve washing results. The Pots-N-Pans cycle automatically uses Hi-Temp Wash.



NOTE: The cycle control knob does not move while water is being heated. Once the water reaches the proper temperature, the cycle control knob will begin moving again.

Air Dry

When Air Dry is selected, the air in the dishwasher is not heated during the "dry" portion of a cycle. Using Air Dry helps save energy, but dishes take longer to dry and some spotting can occur. Some items (such as plastics) may need towel drying. For best drying, use a liquid rinse agent.



NOTE: The dishwasher automatically heats the air in the dishwasher during the "dry" portion of the cycle unless you select Air Dry.

For 900 Model Series:

- Always select the Air Dry option when using the Rinse-Wash Later cycle.

For 915 Model Series:

- The Air Dry option is automatically selected for the Rinse-Wash Later cycle.

Changing a cycle setting

You can change a cycle setting anytime during any cycle.

1. Lift up the door latch to stop the cycle.
2. Turn the cycle control knob clockwise to the desired cycle.
3. If desired, press one or more option pad(s).
4. Check the detergent dispensers. They must be filled properly for the new cycle.

NOTE: Turning the cycle control knob can cause the covered section of the detergent dispenser to open and release the detergent. Check the covered section if setting the Normal, Heavy, or Pots-N-Pans cycle.

5. Close the door firmly until it latches. The dishwasher starts the new cycle.

Changing an option setting

You can change option settings anytime during a cycle as long as the cycle has not passed the point that the option is used. For example, you can press Air Dry anytime before the cycle control knob reaches Dry.



1. Press the Reset Options pad.
2. Press 1 or more Option pad(s).

SETTING THE CONTROLS

Adding an item during a cycle

You can add an additional item to the dishwasher anytime before the cycle control knob reaches Light. Items added after the cycle control knob reaches Light may only be rinsed.

1. Lift up the door latch to stop the cycle. Wait for spraying action to stop before opening the door.
2. Open the door and add the item.
3. Close the door, but **do not** latch it. Wait 30 seconds for the air in the dishwasher to warm up. Doing so reduces the amount of moisture in the vent when restarting a cycle.
4. Close the door firmly until it latches. The dishwasher resumes the cycle.

Using delay wash (on some models)

You can set the dishwasher to start a cycle from 1 to 4 hours later.

1. Press the desired Cycle pad.
2. Press the desired Option pad(s).
3. Turn the cycle control knob clockwise to the number of hours (from 1 to 4 hours) you want the dishwasher to delay before the selected cycle starts.
4. Close and latch the door. The Delay/ Water Heating signal light will come on until the selected cycle starts.

NOTE:

- You can add items while time is counting down. Close and latch the door. The cycle control knob will not advance if the door is unlatched.
- Rinse-Wash Later and Light cycles cannot be delayed.
- The Delay/Water Heating signal light will also come on while the water is heating during all cycles.

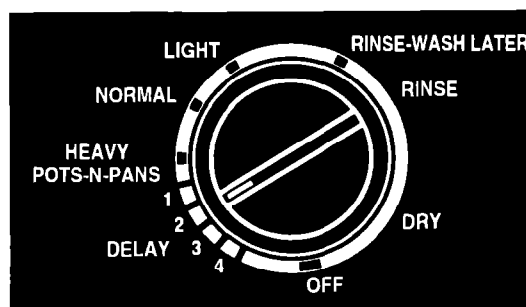

The clean signal light (on some models)

The Clean signal light will come on when a washing cycle is complete. To turn it off, turn the cycle control knob clockwise **slightly** until the light goes off.



Washing Special Items

If you have any doubts about washing a particular piece of tableware, check with the manufacturer to see if it is dishwasher safe.

MATERIAL	DISHWASHER SAFE?	EXCEPTIONS/SPECIAL INFORMATION
Aluminum	Yes	High water temperature and detergents can pit finish of anodized aluminum.
Bottles and Cans	No	Wash bottles and cans by hand. Labels attached with glue can loosen in your dishwasher. Loose labels and glue can clog spray arms or the pump and will reduce washing performance.
Cast Iron	No	Seasoning will be removed and iron will rust.
China/ Stoneware	Yes	Always check manufacturer's recommendations before washing. Antique, hand-painted, or over-the-glaze patterns may fade. Gold leaf can discolor or fade.
Crystal	Yes	Always check manufacturer's recommendations before washing. Some types of leaded crystal can etch with repeated washings.
Gold	No	Gold-colored flatware will discolor.
Glass	Yes	Milk glass will yellow with repeated dishwasher washing.
Hollow-Handle Knives	No	Handles of some knives are attached to the blade with adhesives which may loosen if washed in the dishwasher.
Pewter	No	High water temperatures and detergent can discolor or pit finish.
Disposable Plastics	No	Cannot withstand high water temperatures and detergents.
Plastics	Yes	Always check manufacturer's recommendations before washing. Plastics vary in their capacity to withstand high water temperatures and detergents. Load plastics in top rack only.
Stainless Steel	Yes	Run the Rinse-Wash Later cycle if not washing immediately. Prolonged contact with food containing salt, vinegar, milk products, or fruit juice can damage finish.
Sterling Silver or Silver Plate	Yes	Run the Rinse-Wash Later cycle if not washing immediately. Prolonged contact with food containing salt, acid, or sulfide (eggs, mayonnaise, and seafood) can damage finish.
Tin	No	Can rust.
Wooden Ware	No	Wash by hand. Always check manufacturer's recommendations before washing. Untreated wood can warp, crack, or lose its finish.

Caring for Your Dishwasher

Your new dishwasher is designed to give you many years of dependable service. There are a few things you can do to maintain your dishwasher properly. This section tells you how to clean and care for your dishwasher. Refer to "Solving Common Dishwashing Problems" on pages 22-24 for special cleaning problems. See Installation Instructions for information on storing your dishwasher and for cleaning the drain air gap.

Cleaning the exterior

In most cases, regular use of a soft, damp cloth or sponge and a mild detergent is all that is necessary to keep the outside of your dishwasher nice looking and clean.

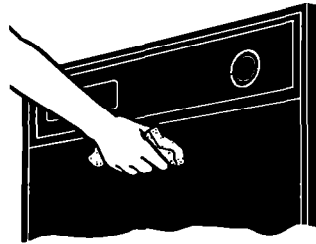

Cleaning the interior

⚠ WARNING



Burn Hazard

Before cleaning interior wait at least twenty minutes after a cycle for the heating element to cool down.

Failure to do so can result in burns.

Hard water minerals may cause a white film to build up on the inside surfaces, especially just beneath the door area. To clean interior:

- Apply powdered dishwasher detergent to a damp sponge to make a paste.

OR

- Use liquid automatic dishwasher detergent and clean with damp sponge.

Wear rubber gloves. **Do not** use any type of cleanser other than dishwasher detergent because it can cause foaming or sudsing.

NOTE: Follow the "Removing spots and film" procedure on page 24 to clean your dishwasher with white vinegar. Remember, this procedure is intended for occasional use only. Vinegar is an acid. Excessive use can damage your dishwasher.

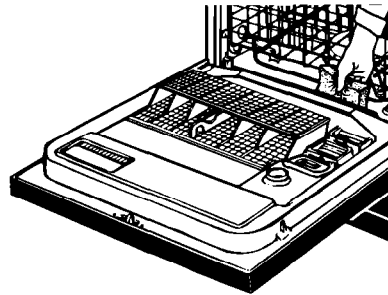

CARING FOR YOUR DISHWASHER

Overfill protector

The overfill protector (in the front right corner of the dishwasher tub) keeps the dishwasher from overflowing. It must be in place for the dishwasher to operate.

Check under the float for objects that may keep the protector from moving up or down.



Saving Energy

Saving energy is important and helps you save money. This section gives you tips on the best ways to save energy with your dishwasher.

Loading tips

- Wash full loads. Running a half-filled dishwasher uses the same amount of electricity and hot water as a fully loaded machine.
- Load correctly for best washing results. Incorrect loading may cause poor washing. You will then need to rewash all or part of load.
- Do not prerinse normally soiled dishes. Select the correct cycle for the load and use the recommended amount of detergent.

Cycle and option tips

- Use the Light cycle whenever possible. The cycle uses less hot water and energy than the Normal cycle.
- Run your dishwasher during off-peak hours. The local utilities recommend that you avoid using too much energy at certain times of the day.
- Do not use the Hi-Temp Wash option if it is not needed. When this option is off and water entering the dishwasher is lower than 140°F, the cycle does not take additional time to heat water during the main wash. In some cases, loads may not dry as well when using the Hi-Temp Wash option.
NOTE: Loads may not wash or dry as well if the water temperature is too low. For best dishwashing results, water must be at least 120°F as it enters the dishwasher.

To check water temperature:

1. Run hot water at the faucet closest to your dishwasher. Set a cup under the faucet, and place a candy or meat thermometer in it.

2. Run hot water for at least 1 minute into the cup, allowing the water to overflow. Check the temperature. If the water temperature is below 120°F, have a



- qualified person raise the thermostat setting on your water heater.
- Use the Air Dry option whenever possible. Allow longer drying times (overnight). Use a rinse agent to improve drying.

Solving Common Dishwashing Problems

A convenient checklist for handling minor performance problems. Go over this list before calling for service. If you are unable to solve your dishwasher's problem, turn to page 26 for service information.

Solution chart

PROBLEM	CAUSE	SOLUTION
Food soil left on dishes	Improper loading	Follow loading instructions on pages 7-11.
	Water temperature too low	Use the Hi-Temp Wash option. If needed, turn home water heater up to ensure water entering dishwasher is 120°F (49°C) minimum. See "To check water temperature" on page 21. NOTE: In some cases, loads may not dry as well when using the Hi-Temp Wash option.
	Use of incorrect, too little, or ineffective detergent	Use recommended dishwasher detergents only. Follow recommendations on page 12 for amounts. Never use less than one tablespoon per load. Detergent must be fresh to be effective. Always store detergent tightly closed in a cool, dry place.
	Detergent cakes in dispenser	Use fresh detergent only. Do not allow detergent to sit for several hours in a wet dispenser. Check dispenser for caked detergent. Clean dispenser when caked detergent is present.
	Insufficient fill due to low water pressure	Home water pressure should be 20 to 120 pounds per square inch (psi) for proper dishwasher fill. A booster pump on the water supply may be necessary if pressure is too low.
	Slowdown of wash arm due to high suds	Never use soap or laundry detergents. Use recommended dishwasher detergents only.
Spotting and filming	Hard water or high mineral content in water	Use rinse agent to help prevent spotting and filming. See page 13. To remove hard water film, see "Removing spots and film" on page 24.
	Water temperature too low	Use the Hi-Temp Wash option. If needed, turn home water heater up to ensure water entering dishwasher is 120°F (49°C) minimum. See "To check water temperature" on page 21. NOTE: In some cases, loads may not dry as well when using the Hi-Temp Wash option.

SOLVING COMMON DISHWASHING PROBLEMS

PROBLEM	CAUSE	SOLUTION
Spotting and filming (continued)	Use of incorrect detergents	Use recommended dishwasher detergents only.
	Incorrect amount of detergent	Follow recommendations on page 12 for amount. Heavy soil and/or hard water generally require extra detergent.
	Use of ineffective detergents	Use fresh detergent. Store detergent tightly closed in a cool, dry place. Discard lumpy detergent.
	Insufficient fill due to low water pressure	Home water pressure should be 20 to 120 psi for proper dishwasher fill. A booster pump on the water supply may be necessary if pressure is too low.
Cycle takes extremely long time	Water temperature is too low	If needed, turn home water heater up to ensure water entering dishwasher is 120°F minimum. See "To check water temperature" on page 21.
	Dishwasher is not installed properly	Undercounter dishwashers require adequate enclosure for proper operation. See Installation Instructions for complete information.
Dishes do not dry completely	Dishes do not drain properly	Dishes must have proper water drainage. Do not overload. Follow instructions for loading dishwasher on pages 7-11. Use a liquid rinse agent to speed draining.
	Plastics	Some plastics, due to material, may need to be towel dried.
Silica film or etching (silica film is a white iridescent deposit; etching is a cloudy film)	Water chemical reaction with certain types of glassware – usually caused by some combination of soft or softened water, alkaline washing solutions, insufficient rinsing, overloading the dishwasher, and heat of drying.	It may not be possible to prevent problem, except by hand washing. To slow this process, use a minimum amount of detergent but not less than 1 tablespoon per load. Use a liquid rinse agent and under-load the dishwasher to allow thorough rinsing. Silica film and etching are permanent and cannot be removed. Use the Air Dry option.
Black or gray marks on dishes	Aluminum items touching dishes	Load aluminum items so that they will not rub against dishes during washing. Do not wash throwaway aluminum items in the dishwasher because they may break down and cause marking. Remove aluminum markings by using a mild abrasive cleanser.

continued on next page

SOLVING COMMON DISHWASHING PROBLEMS

PROBLEM	CAUSE	SOLUTION
White spots on cookware with non-stick finish	Seasoning removed by dishwasher detergents	Reseason cookware after dishwasher washing.
Brown stains on dishes and dishwasher interior	High iron content in water supply	Remove by washing dishes (after food soil has been removed) with 1 teaspoon to 1 tablespoon of citric acid crystals added to covered section of detergent dispenser. Do not use detergent. Follow with a Light cycle and detergent. If treatment is needed more often than every other month, we recommend installation of an iron removal unit.
Orange stains on dishwasher interior	Large amounts of tomato-based foods on dishes placed in the dishwasher	Stains will not affect dishwasher performance and can gradually fade over time. Regular use of Rinse-Wash Later reduces the chance of staining. If air in the dishwasher is heated during the "dry" portion of the cycle, stains may fade slower than if the Air Dry option is selected.
Odor in the dishwasher	Dishes only washed every 2 to 3 days	Run a Rinse-Wash Later cycle at least once or twice a day until a full load is accumulated.
Chipping of dishes	Improper loading	Load dishes and glasses so they are stable and do not strike together from washing action. Moving racks in and out slowly will also minimize chipping. NOTE: Some types of china and glassware are too delicate for automatic dishwashing and should be hand washed; for example: antiques, feather-edged crystal, and similar items.

Removing spots and film

Keep the rinse agent dispenser filled with a liquid rinse agent. A rinse agent prevents water from forming droplets and drying as spots or streaks.

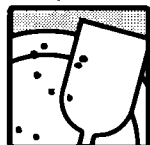

To remove spots and film on dishes and glasses, or hard water film/lime buildup on the interior of the dishwasher, you may use white vinegar with the following procedure:

1. Load clean dishes and glasses in dishwasher (see pages 7-11). Do not load silverware or other metals in the dishwasher.

2. Put 2 cups of household vinegar (in a glass or dishwasher safe measuring cup) standing upright in the bottom rack.
3. Close and latch the door.
4. Select the Normal cycle and Air Dry option. Do not use detergent. Allow the dishwasher to complete the entire cycle.

NOTE: This cleaning procedure is intended for occasional use only. Vinegar is an acid. Excessive use may damage your dishwasher.

Troubleshooting

Before calling for assistance please check the chart below for problems you can fix. It could save you the cost of a service call.

Dishwasher problems

PROBLEM	CHECK THE FOLLOWING
Dishwasher does not run or stops during a cycle	<p>Is the door tightly closed and securely latched?</p> <p>Has the cycle been set correctly? See pages 6 and 14-15.</p> <p>Is the dishwasher set for a delay start? See page 17.</p> <p>Has a household fuse or circuit breaker blown or tripped?</p> <p>If the motor stopped because of an overload, it will automatically reset itself within a few minutes. If it does not start, call for service.</p> <p>Is the water supply turned on?</p> <p>Is the dishwasher wired into a live circuit with the proper voltage?</p>
Dishwasher runs too long	<p>Cycle times depend on the temperature of the water entering the dishwasher. Cooler water results in longer cycle times.</p> <p>Undercounter dishwashers require adequate enclosure for proper operation. See Installation Instructions for complete information.</p>
Dishwasher will not fill	<p>Is overfill protector stuck in "up" position? Overfill protector should move up and down freely. Press down to release. See page 20.</p>
Water remains in dishwasher	<p>Allow cycle to finish. A small amount of water remaining is normal.</p> <p>Check the drain air gap (if installed). If it is clogged, follow the manufacturer's cleaning instructions.</p>
Detergent remains in covered section of dispenser	<p>Has the cycle completed?</p> <p>Is the detergent fresh and dry without lumps? See page 12.</p> <p>Is the bottom rack in backwards? The rack bumpers must face the dishwasher door.</p>
Dishes not as dry as you expected	<p>Is the rinse agent dispenser empty? Using a rinse agent greatly improves drying. See page 13.</p> <p>Do not use Air Dry option on the next load. See page 16.</p>
Grinding, grating, crunching, or buzzing sounds	<p>Has a hard object entered the POWER CLEAN™ module? The sound should stop when the object is ground up.</p>
White residue appears on front of access panel	<p>Is too much detergent being used? See page 12 for recommended amounts of detergent.</p> <p>Some liquid detergents develop excess foam and residue on panel. Try a different brand to reduce foaming and eliminate buildup.</p>
Dishwasher will not close	<p>Is the bottom rack in backwards? The rack bumpers must face the dishwasher door.</p>

Requesting Assistance or Service

Before calling for assistance or service, please check "Troubleshooting" on page 25. It may save you the cost of a service call. If you still need help, follow the instructions below.

1. If you need assistance*...

Call the Whirlpool Consumer Assistance Center telephone number. Dial toll-free from anywhere in the U.S.A.:



1-800-253-1301

and talk with one of our trained consultants. The consultant can instruct you in how to obtain satisfactory operation from your appliance or, if service is necessary, recommend a qualified service company in your area.

If you prefer, write to:

Mr. William Clark
Consumer Assistance Representative
Whirlpool Corporation
2000 North M-63
Benton Harbor, MI 49022-2692

Please include a daytime phone number in your correspondence.

2. If you need service* ...

Whirlpool has a nationwide network of authorized service companies. Whirlpool service technicians are trained to fulfill the product warranty and provide after-warranty service, anywhere in the United States. To locate the authorized Whirlpool service company in your area, call our Consumer Assistance Center telephone number (see Step 1) or look in your telephone directory Yellow Pages under:



**• APPLIANCE-HOUSEHOLD-
MAJOR, SERVICE & REPAIR**

- See: Whirlpool Appliances or
Authorized Whirlpool Service
(Example: XYZ Service Co.)

**• WASHING MACHINES &
DRYERS, SERVICE & REPAIR**

- See: Whirlpool Appliances or
Authorized Whirlpool Service
(Example: XYZ Service Co.)

3. If you need FSP® replacement parts ...

FSP is a registered trademark of Whirlpool Corporation for quality parts. Look for this symbol of quality whenever you need a replacement part for your WHIRLPOOL® appliance. FSP replacement parts will fit right and work right, because they are made to the same exacting specifications used to build every new WHIRLPOOL appliance.

To locate FSP replacement parts in your area, refer to Step 2 or call the Whirlpool Consumer Assistance Center number in Step 1.

4. If you are not satisfied with how the problem was solved ...

- Contact the Major Appliance Consumer Action Program (MACAP). MACAP is a group of independent consumer experts that voices consumer views at the highest levels of the major appliance industry.
- Contact MACAP only when the dealer, authorized servicer, and Whirlpool have failed to resolve your problem.

Major Appliance Consumer Action Program
20 North Wacker Drive
Chicago, IL 60606

- MACAP will in turn inform us of your action.

* When asking for help or service:

Please provide a detailed description of the problem, your appliance's complete model and serial numbers, and the purchase date. (See page 2.) This information will help us respond properly to your request.

Index

This index is alphabetical. Look for the word or phrase you are interested in, then look for the page number.

<u>TOPIC</u>	<u>PAGE</u>	<u>TOPIC</u>	<u>PAGE</u>
BOTTOM RACK	9	LOADING	
CLEANING		Bottom rack	9
Exterior	19	Preparing to load	7
Interior	19	Silverware basket	8
CLEAN LIGHT	17	Top rack	10
COMMON WASHING PROBLEMS		OPTIONS	16
Solving	22-24	OVERFILL PROTECTOR	20
CYCLE		PARTS/FEATURES	4
Canceling	15	RESPONSIBILITIES	
Selecting	14-15	Owner	2
DELAY LIGHT	17	RINSE AGENT	
DELAY WASH	17	Using	13
DETERGENT		SAFETY	3
Tips	12	SERVICE	
Use chart	12	Parts	26
DISHWASHER OPERATION		Requesting	26
Adding an item during cycle	17	SILVERWARE BASKET	8
Changing cycle	16	SPECIAL ITEMS	
Starting	6	Washing	18
Stopping	6	SPOTS/FILM	
DISPENSER		Removing	24
Detergent	12	TOP RACK	10
Rinse agent	13	TROUBLESHOOTING	25
ENERGY		WARRANTY	32
Saving	21	WATER	
FEATURES/PARTS	4	Checking temperature	21
FILM/SPOTS		WATER HEATING LIGHT	17
Removing	24		

**POWER CLEAN™ washing system parts
covered by your warranty**

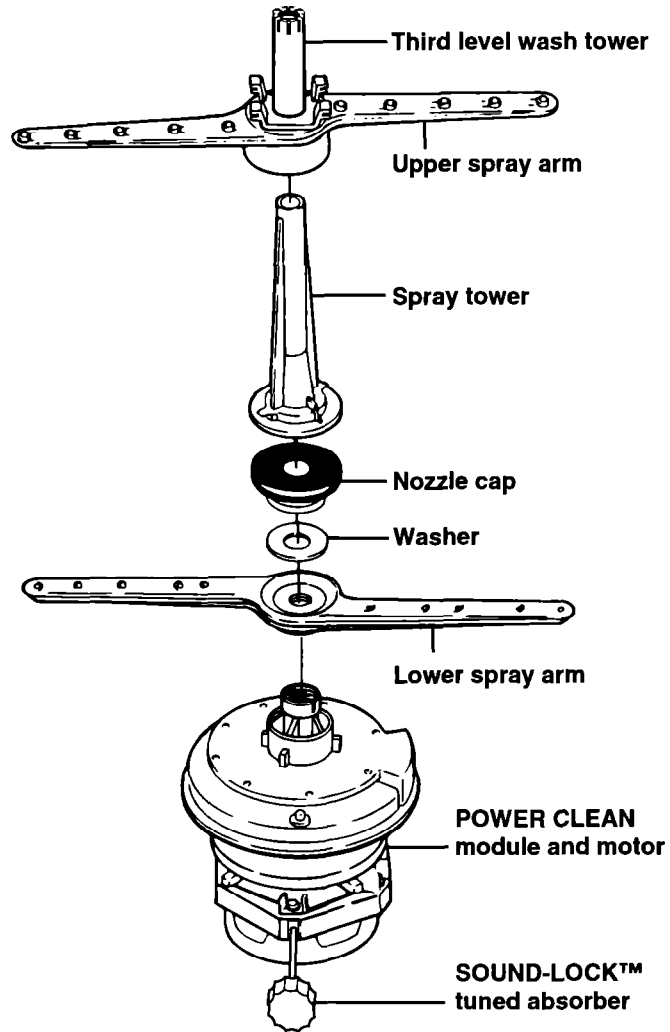

WHIRLPOOL® Dishwasher Warranty

LENGTH OF WARRANTY	WHIRLPOOL WILL PAY FOR
FULL ONE-YEAR WARRANTY From Date of Purchase	FSP® replacement parts and repair labor to correct defects in materials or workmanship. Service must be provided by an authorized Whirlpool service company.
LIMITED ONE-YEAR WARRANTY Second Year From Date of Purchase	FSP replacement parts for any part of the POWER CLEAN™ washing system if defective in materials or workmanship. These parts are shown on page 31 of this book.
FULL TWENTY-YEAR WARRANTY From Date of Purchase	FSP replacement parts and repair labor for the DURAPERM™ tub and/or inner door should they fail to contain water due to defective materials or workmanship. Service must be provided by an authorized Whirlpool service company.
WHIRLPOOL WILL NOT PAY FOR	
<p>A. Service calls to:</p> <ol style="list-style-type: none"> 1. Correct the installation of your dishwasher. 2. Instruct you how to use your dishwasher. 3. Replace house fuses or correct house wiring or plumbing. <p>B. Repairs when your dishwasher is used in other than normal, single-family household use.</p> <p>C. Pickup and delivery. Your dishwasher is designed to be repaired in the home.</p> <p>D. Damage to your dishwasher caused by accident, misuse, fire, flood, acts of God, or use of products not approved by Whirlpool.</p> <p>E. Any labor costs during limited warranties.</p> <p>F. Repairs to parts or systems caused by unauthorized modifications made to the appliance.</p>	

6/94

WHIRLPOOL CORPORATION SHALL NOT BE LIABLE FOR INCIDENTAL OR CONSEQUENTIAL DAMAGES. Some states do not allow the exclusion or limitation of incidental or consequential damages, so this exclusion or limitation may not apply to you. This warranty gives you specific legal rights, and you may also have other rights which vary from state to state.

Outside the United States, a different warranty may apply. For details, please contact your authorized Whirlpool dealer.

If you need service, first see the "Troubleshooting" section of this book. After checking "Troubleshooting," additional help can be found by checking the "Requesting Assistance or Service" section, or by calling our Consumer Assistance Center telephone number, **1-800-253-1301**, from anywhere in the U.S.A.